

86 Wi-Fi lighting Switch with touch panel specifications



— .Hardware installation:

Please install your wi-fi switch as below photo indicated.

Input: N for negative, L for positive

Output : wire: L1, L2, L3

Put the wire into the pole and locked it accordingly.

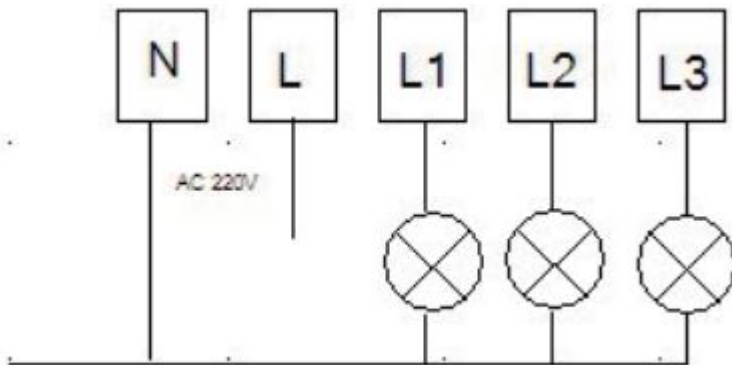

二. Software installation:

A. APP install:

Scan the QR code printed on instruction manual or download the APP from APP store. After download finish, install and run it.

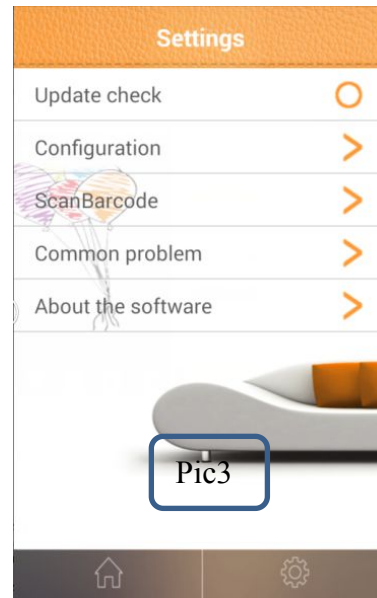

B. Android system configuration:

1. Click "CTO lighting switch" to run the APP (Pic.1).
2. Click "device" on (Pic.2) then go to setting page as (Pic.3).
3. Click "configuration".
4. Press and hold the power key ,as show on Pic.4 , on the wi-fi lighting switch for 5sec. LEDs will start flashing, and waiting to be configured.
5. Back to APP, select the wi-fi router which going to connect and type in the password of the router. And click the "setting" button underneath to start configuration. (pic.5 & pic.6)
6. Once configuration successful, a page for adding device will exit on the APP (Pic.7), named for your device and type in your own security password, then click "confirm" .(Remark: this password will be used for sharing this device to other users, don't forget)

7. Back to the device list should find the new device already added, Once the  icon light

on, means device successfully connect to cloud server (Pic8) . It is ready to be operated. Click 

Can switch all the device on/off. Click  move to separate control page as (Pic.9). Switch on/off for each loof separating.



Pic4

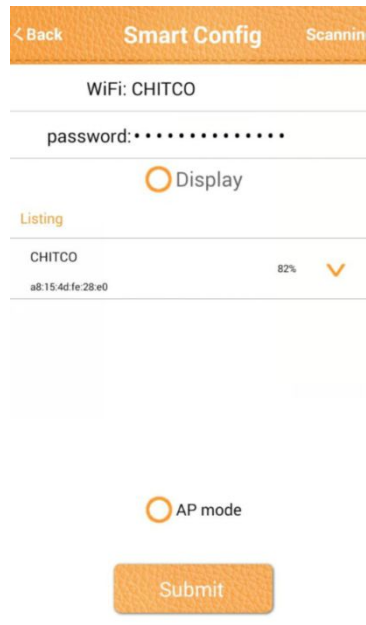

Pic5

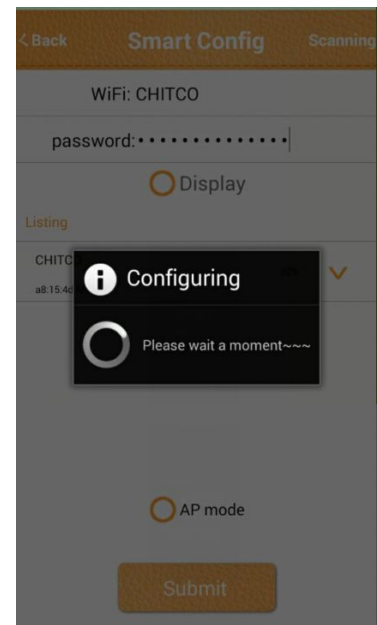

Pic6



C. IOS system configuration

1. Click "CTO lighting switch" to run the APP (Pic1)
2. Press "HOME" key of the iphone and go to "setting" to select the wi-fi. After connected, back to the APP.
3. all steps after are same as android operation.

三、Timer setting

click  and click  Timing , go to timing setting page. Set the timer for all or each. (Pic8~Pic11)

四、 modify the device information

Click  and click  Information to renamed your devices.(Pic8~Pic9)

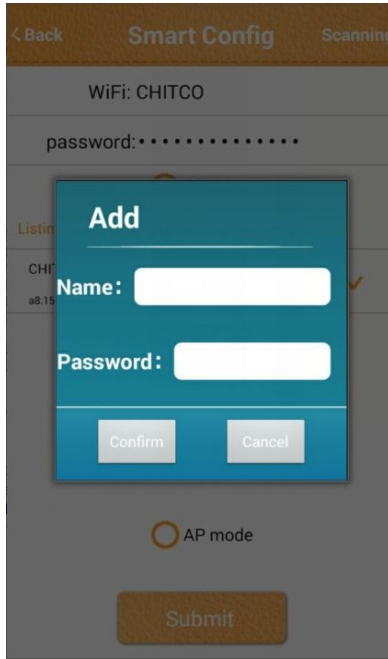

Pic7



Pic8



Pic9



Pic10

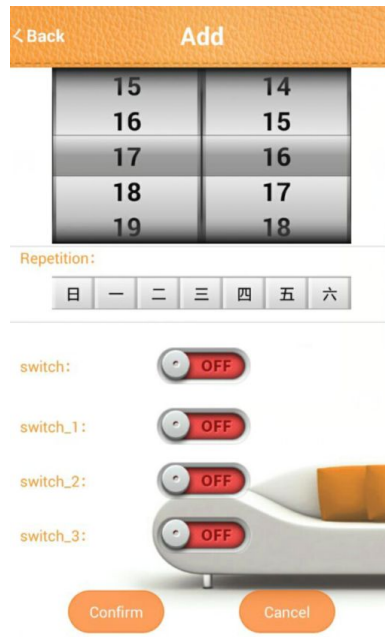

Pic11

五、 delete/share the device

Select the device on device list. Press and hold it then a choice menu come out. Select "delete" to delete the device from the list(Pic12~Pic13). Once the device deleted,user can not control the switch again but re-configuration. Select "share" to share this device to other user. Once select share, a QR code will be created(Pic14). The new user just need to scan the QR code can get the device on the list. No need re-configuration. (Remark: new users have to use the Scan function built in on APP, using the third party scan software will be fail. Find the scan barcode on setting page.)



Pic12

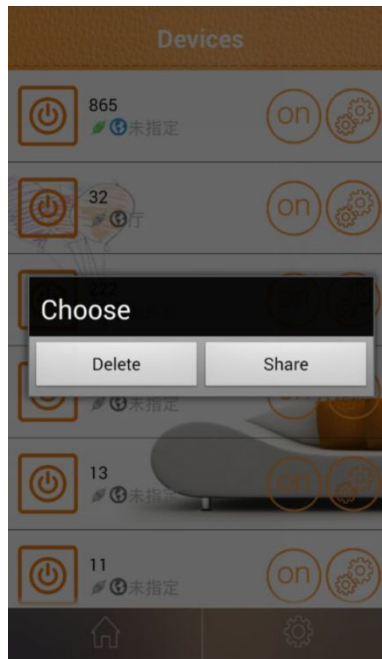

Pic13



Pic14